

Data Sheet

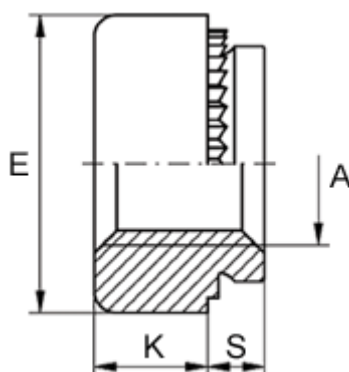

Article number: 12501000020500
Description: KLEE-coil 501 000 020.500
M2 Stainless 1.4305

Measures



Female thread A	= M2
Height K	= 2.0
Max recess height	= 1.0
Min distance to edge	= 3.0
Outer diameter E	= 6.0
Plate thickness	= 1.1 to 1.4
Recommended bore diameter +0.05	= 4.00